

PRODUCT DATA AND APPLICATION SHEET

PRODUCT NAME **Changeover Switch 40amp Enclosed**

PRODUCT CODE UKT3-4-8213-E40

DESCRIPTION Changeover Switch 40amp Enclosed 4 Pole

BOX QUANTITY **1** **OUTER QUANTITY** **24**

FEATURES



- Changeover switch rotary with OFF, 4 Pole, Enclosed 40Amp, engraved 1 0 2 mounted in a large fibox polycarbonate box, front operated.
- The tesla cam switches are designed, constructed and tested in accordance with national and international standards including VDE, DIN, IEC, UL and CSA to provide you with a reliable.
- A wide range of amp ratings is available dependent on model, including 20A, 32A, 63A and 100A and ensures a complete solution is available for all your applications.

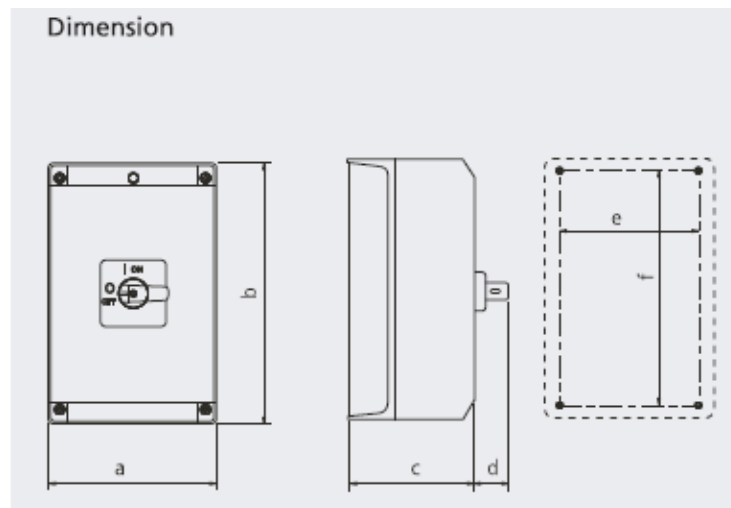

Frame	UKT3-4-8213-E40
a	116
b	176
c	101
d	35
e	90
f	165

PRODUCT DATA AND APPLICATION SHEET

PRODUCT NAME **Changeover Switch 40amp Enclosed**
(Continued)

SPECIFICATIONS	
Product Series	UKT
Un, Nominal Operational Voltage, AC	690 V AC
Ui, Rated Insulation Voltage	690 V (rms)
Uimp, Impulse Withstand Voltage	6 kV
Rated Frequency	50/60 Hz
Number of Poles	4
Ith, Thermal Current, Open	40 A
Ie, Rated Operational Current, AC-21a, 690V	40 A @ 690V
IP Rating	IP54
IP Rating Front	IP66
Switching Function	Changeover with Off
Mounting	Enclosed
Height	176 mm (b)
Width	116 mm (a)
Depth	101 mm (c)

